

Access Control Terminal

Quick Start Guide

UD39491B

Quick Guide

1 Installation and Wiring

Check the environment, install the device and wire the devices.

2 Activation and Settings

Activate the device and perform relevant operations according to the commands.

1 Installation and Wiring

1.1 Check Environment

- The minimum bearing weight of the wall or other places should be 3 times heavier than the device weight.
- Please prepare the following tools and accessories: screwdriver (self purchased), screws, cables, and adapters (self purchased).

1.2 Installation

- 1 Attach the installation sticker to the wall about 1.45 m from the ground or the location where the device needs to be installed, and punch the hole according to the hole location (hole 1 and hole 2) on the sticker and wall.
- 2 Insert the plastic sleeve of the provided expansion screw into the punched hole.

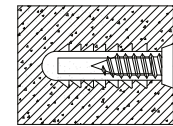
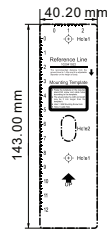

- 3 Make sure the cables are threaded through the hole.
- 4 Secure the mounting plate on the gang box with two supplied screws (PA4X25-SUS).
- 5 Complete the wiring. See the wiring diagram below (1.3) for details.
- 6 Hang the device into the plate from top to bottom. Secure the device on the mounting plate with 1 supplied screw (SC-KM3X8-T10-SUS-NL).

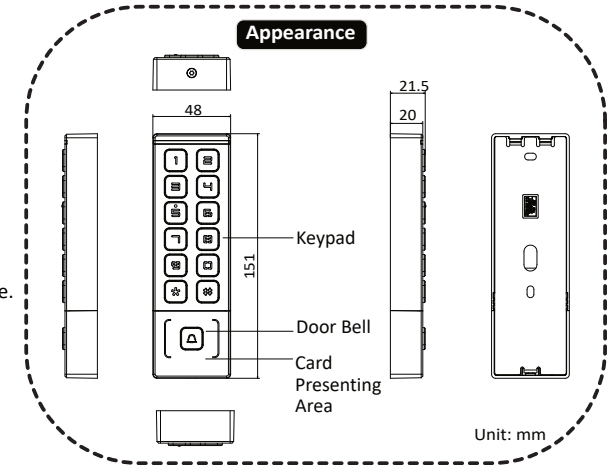
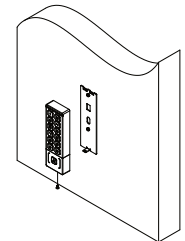
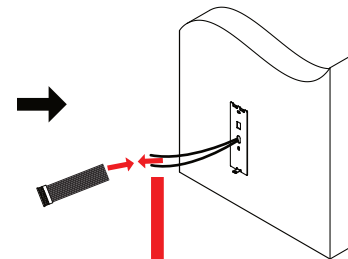
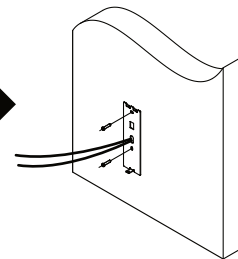
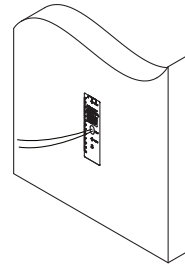

1.3 Wiring

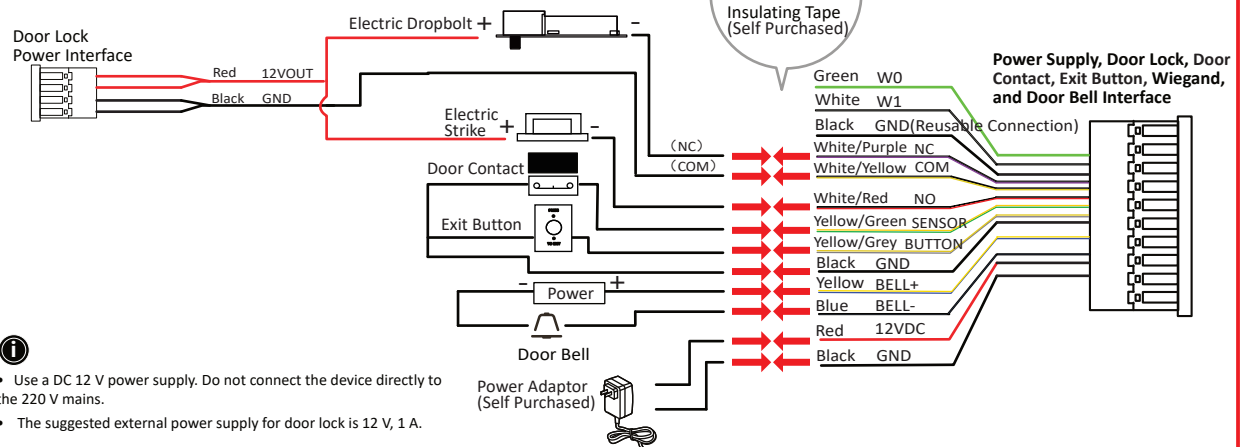

Scan the QR code to get the user manual for more details.



2 Activation and Other Operation Commands

The device supports activation and operation through device-side commands. It also supports activation and operation on the mobile phone by connecting to the device hotspot.
(If it is activated through the mobile phone, it cannot be operated through the device. If it is activated through the device, you can operate on the mobile phone.)

Operate on the Device

Common Operation Commands

Main Process	Steps	Commands
Power on and Activate Device	1. Activate the device.	[*][0][#] [Programming Password (6 to 8 Digits)] [Repeat Programming Password (6 to 8 Digits)] [#]
	2. Enter the programming mode.	[Programming Password (6 to 8 Digits)] [*][0][#]
Manage Password and Cards	3. Add user card.	[01] [Swipe Card]...
	4. Go back to programming mode.	[*]
	5. Set door opening password.	[03] [Door Opening Password (4 to 8 Digits)] [Repeat Door Opening Password(4 to 8 Digits)] [#]
	6. Exit the programming mode.	[*][#]
Test	7. Test opening door with the card.	Open door with the card.
	8. Test opening door with the password.	Open the door with door opening password, and finish with pressing [#].

Other Operation Commands

This manual lists only the common operation commands. You can refer to the user manual to get following operation commands:

Add or remove functional cards (including managing cards, adding cards, and deleting cards), add or delete user cards in batches, add or remove user codes, set door parameter, enable parameter, set NFC, set card reader Wiegand mode, restore to default parameters, reboot the device, and restore to factory settings.

Common Operation Prompt

Status	Indicator	Prompt Audio
Device is Powered on and in Self-test	Light flashes red and green once.	When the light ends, the buzzer beeps 1 sound.
Device is Inactivated	Light flashes orange slowly.	/
Device is Activated	Light is solid green for 3 s.	The buzzer rings for 3 s.
Activating Device failed	Light flashes red slowly for 2 s.	The buzzer rings 5 times quickly.
Device is in Programming Mode	Light flashes green quickly.	/
Device is in Standby Status	Light flashes green slowly.	/
Operation Succeeded	Light is solid green for 2 s.	The buzzer rings 2 times quickly.
Operation Failed	Light is solid red for 2 s.	The buzzer rings 3 times slowly.
Authenticated	Light is solid green for 2 s.	The buzzer rings 2 times quickly.
Authenticating Failed	Light is solid red for 2 s.	The buzzer rings 3 times slowly.

Operate on the Mobile Web

Activate via Mobile Web

You can activate the device via mobile web.

1. After the device is powered on, the hotspot is enabled by default. Search for and connect to the device hotspot on your phone.

- Device hotspot name is AP_Serial No.
- Initial password of device hotspot is Serial No.
- After restarting or switching from non-AP mode to AP mode after activation (press and hold the number button 5 to switch AP mode), the hotspot password will be changed to the activation password.
- You can log in to the mobile web client only when the device is in AP mode.

2. Open the browser address bar of the mobile phone and enter 192.168.8.1 to enter the activation interface.

3. Set the activation password and confirm it.

- The password must be 8 to 16 characters long.
- The password must be composed of two or more combinations of numbers, lowercase letters, uppercase letters, and special characters.
- The password cannot contain the user name, 123, admin, 4 or more consecutive digits in increments or decrement, or the same symbol.

4. Tap Activate Device.

About this Document

- This Document includes instructions for using and managing the Product. Pictures, charts, images and all other information hereinafter are for description and explanation only.
- The information contained in the Document is subject to change, without notice, due to firmware updates or other reasons. Please find the latest version of the Document at the Hikvision website (<https://www.hikvision.com>). Unless otherwise agreed, Hangzhou Hikvision Digital Technology Co., Ltd. or its affiliates (hereinafter referred to as "Hikvision") makes no warranties, express or implied.
- Please use the Document with the guidance and assistance of professionals trained in supporting the Product.

About this Product

This product can only enjoy the after-sales service support in the country or region where the purchase is made.

Acknowledgment of Intellectual Property Rights

- Hikvision owns the copyrights and/or patents related to the technology embodied in the Products described in this Document, which may include licenses obtained from third parties.
- Any part of the Document, including text, pictures, graphics, etc., belongs to Hikvision. No part of this Document may be excerpted, copied, translated, or modified in whole or in part by any means without written permission.
- **HIKVISION** and other Hikvision's trademarks and logos are the properties of Hikvision in various jurisdictions.
- Other trademarks and logos mentioned are the properties of their respective owners.

LEGAL DISCLAIMER

- TO THE MAXIMUM EXTENT PERMITTED BY APPLICABLE LAW, THIS DOCUMENT AND THE PRODUCT DESCRIBED, WITH ITS HARDWARE, SOFTWARE AND FIRMWARE, ARE PROVIDED "AS IS" AND "WITH ALL FAULTS AND ERRORS". HIKVISION MAKES NO WARRANTIES, EXPRESS OR IMPLIED, INCLUDING WITHOUT LIMITATION, MERCHANTABILITY, SATISFACTORY QUALITY, OR FITNESS FOR A PARTICULAR PURPOSE. THE USE OF THE PRODUCT BY YOU IS AT YOUR OWN RISK. IN NO EVENT WILL HIKVISION BE LIABLE TO YOU FOR ANY SPECIAL, CONSEQUENTIAL, INCIDENTAL, OR INDIRECT DAMAGES, INCLUDING, AMONG OTHERS, DAMAGES FOR LOSS OF BUSINESS PROFITS, BUSINESS INTERRUPTION, OR LOSS OF DATA, CORRUPTION OF SYSTEMS, OR LOSS OF DOCUMENTATION, WHETHER BASED ON BREACH OF CONTRACT, TORT (INCLUDING NEGLIGENCE), PRODUCT LIABILITY, OR OTHERWISE, IN CONNECTION WITH THE USE OF THE PRODUCT, EVEN IF HIKVISION HAS BEEN ADVISED OF THE POSSIBILITY OF SUCH DAMAGES OR LOSS.
- YOU ACKNOWLEDGE THAT THE NATURE OF THE INTERNET PROVIDES FOR INHERENT SECURITY RISKS, AND HIKVISION SHALL NOT TAKE ANY RESPONSIBILITIES FOR ABNORMAL OPERATION, PRIVACY LEAKAGE OR OTHER DAMAGES RESULTING FROM CYBER-ATTACK, HACKER ATTACK, VIRUS INFECTION, OR OTHER INTERNET SECURITY RISKS; HOWEVER, HIKVISION WILL PROVIDE TIMELY TECHNICAL SUPPORT IF REQUIRED.
- YOU AGREE TO USE THIS PRODUCT IN COMPLIANCE WITH ALL APPLICABLE LAWS, AND YOU ARE SOLELY RESPONSIBLE FOR ENSURING THAT YOUR USE CONFORMS TO THE APPLICABLE LAW. ESPECIALLY, YOU ARE RESPONSIBLE, FOR USING THIS PRODUCT IN A MANNER THAT DOES NOT INFRINGE ON THE RIGHTS OF THIRD PARTIES, INCLUDING WITHOUT LIMITATION, RIGHTS OF PUBLICITY, INTELLECTUAL PROPERTY RIGHTS, OR DATA PROTECTION AND OTHER PRIVACY RIGHTS.

YOU SHALL NOT USE THIS PRODUCT FOR ANY PROHIBITED END-USES, INCLUDING THE DEVELOPMENT OR PRODUCTION OF WEAPONS OF MASS DESTRUCTION, THE DEVELOPMENT OR PRODUCTION OF CHEMICAL OR BIOLOGICAL WEAPONS, ANY ACTIVITIES IN THE CONTEXT RELATED TO ANY NUCLEAR EXPLOSIVE OR UNSAFE NUCLEAR FUEL-CYCLE, OR IN SUPPORT OF HUMAN RIGHTS ABUSES.

- IN THE EVENT OF ANY CONFLICTS BETWEEN THIS DOCUMENT AND THE APPLICABLE LAW, THE LATTER PREVAILS.

Data Protection

- To protect data, the development of Hikvision Products incorporates privacy by design principles. For example, for Products with facial recognition features, biometrics data is stored in your Products with encryption method; for fingerprint Products, only fingerprint template will be saved, which is impossible to reconstruct a fingerprint image.

- As a data controller/processor, you may process personal data, including collection, storage, use, processing, disclosure, deletion, etc. You are advised to pay attention to and comply with applicable laws and regulations related to the protection of personal data, including without limitation, conducting security controls to safeguard personal data, such as, implementing reasonable administrative and physical security controls, conduct periodic reviews and the assessments of the effectiveness of your security controls.

© Hangzhou Hikvision Digital Technology Co., Ltd. All rights reserved.



Warning

- In the use of the product, you must be in strict compliance with the electrical safety regulations of the nation and region.
- CAUTION: To reduce the risk of fire, replace only with the same type and rating of fuse.
- To prevent possible hearing damage, do not listen at high volume levels for long periods. Please use the power adapter, which is provided by normal company. The power consumption cannot be less than the required value.
- Do not connect several devices to one power adapter as adapter overload may cause over-heat or fire hazard.
- Please make sure that the power has been disconnected before you wire, install or dismantle the device.
- When the product is installed on wall or ceiling, the device shall be firmly fixed.
- If smoke, odors or noise rise from the device, turn off the power at once and unplug the power cable, and then please contact the service center.
- If the product does not work properly, please contact your dealer or the nearest service center. Never attempt to disassemble the device yourself. (We shall not assume any responsibility for problems caused by unauthorized repair or maintenance.)
- To prevent possible hearing damage, do not listen at high volume levels for long periods. Please use the power adapter, which is provided by normal company. The power consumption cannot be less than the required value.
- Do not connect several devices to one power adapter as adapter overload may cause over-heat or fire hazard.

- Please make sure that the power has been disconnected before you wire, install or dismantle the device.
- When the product is installed on wall or ceiling, the device shall be firmly fixed.
- If smoke, odors or noise rise from the device, turn off the power at once and unplug the power cable, and then please contact the service center.
- If the product does not work properly, please contact your dealer or the nearest service center. Never attempt to disassemble the device yourself. (We shall not assume any responsibility for problems caused by unauthorized repair or maintenance.)



Caution

- Identifies the positive terminal(s) of equipment which is used with, or generates direct current. +
- No naked flame sources, such as lighted candles, should be placed on the equipment. The USB port of the equipment is used for connecting to a USB flash drive only. The serial port of the equipment is used for debugging only.
- Burned fingers when handling the fingerprint sensor metal. Wait one-half hour after switching off before handling the parts.
- Install the equipment according to the instructions in this manual.
- To prevent injury, this equipment must be securely attached to the floor/wall in accordance with the installation instructions.
- Do not drop the device or subject it to physical shock, and do not expose it to high electromagnetic radiation. Avoid the equipment installation on vibrations surface or places subject to shock (ignorance can cause equipment damage).
- Do not place the device in extremely hot (refer to the specification of the device for the detailed operating temperature), cold, dusty or damp locations, and do not expose it to high electromagnetic radiation.
- The device cover for indoor use shall be kept from rain and moisture.
- Exposing the equipment to direct sun light, low ventilation or heat source such as heater or radiator is forbidden (ignorance can cause fire danger).
- Do not aim the device at the sun or extra bright places. A blooming or smear may occur otherwise (which is not a malfunction however), and affecting the endurance of sensor at the same time.
- Please use the provided glove when open up the device cover, avoid direct contact with the device cover, because the acidic sweat of the fingers may erode the surface coating of the device cover.
- Please use a soft and dry cloth when clean inside and outside surfaces of the device cover, do not use alkaline detergents.
- Please keep all wrappers atier unpack them for future use. In case of any failure occurred, you need to return the device to the factory with the original wrapper. Transportation without the original wrapper may result in damage on the device and lead to additional costs.
- Improper use or replacement of the battery may result in hazard of explosion.
- Replace with the same or equivalent type only.
- Biometric recognition products are not 100% applicable to anti-spoofing environments.
- If you require a higher security level, use multiple authentication modes.
- Please make sure that the biometric recognition accuracy will be affected by the collected pictures' quality and the light in the environment, which cannot be 100% correct.